



© Copyright 2006. Black Box Corporation. All rights reserved.

1000 Park Drive • Lawrence, PA 15055-1018 • 724-746-5500 • Fax 724-746-0746



JUNE 2006
LPD500A
LPD501A
LPD502A
LPD503A
LPD506A
LPD507A

PD PoE 10/100BASE-TX to 100BASE-FX Media Converter

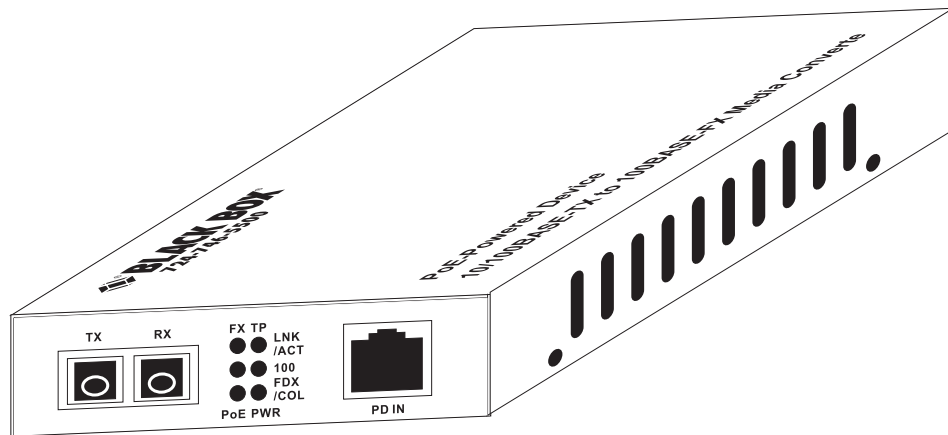

**CUSTOMER
SUPPORT
INFORMATION**

Order **toll-free** in the U.S.: Call **877-877-BBOX** (outside U.S. call **724-746-5500**)
FREE technical support 24 hours a day, 7 days a week: Call **724-746-5500** or fax **724-746-0746**
Mailing address: **Black Box Corporation**, 1000 Park Drive, Lawrence, PA 15055-1018
Web site: www.blackbox.com • E-mail: info@blackbox.com

**FEDERAL COMMUNICATIONS COMMISSION
AND
INDUSTRY CANADA
RADIO FREQUENCY INTERFERENCE STATEMENTS**

This equipment generates, uses, and can radiate radio-frequency energy, and if not installed and used properly, that is, in strict accordance with the manufacturer's instructions, may cause interference to radio communication. It has been tested and found to comply with the limits for a Class A computing device in accordance with the specifications in Subpart B of Part 15 of FCC rules, which are designed to provide reasonable protection against such interference when the equipment is operated in a commercial environment. Operation of this equipment in a residential area is likely to cause interference, in which case the user at his own expense will be required to take whatever measures may be necessary to correct the interference.

Changes or modifications not expressly approved by the party responsible for compliance could void the user's authority to operate the equipment.

This digital apparatus does not exceed the Class A limits for radio noise emission from digital apparatus set out in the Radio Interference Regulation of Industry Canada.

Le présent appareil numérique n'émet pas de bruits radio électriques dépassant les limites applicables aux appareils numériques de la classe A prescrites dans le Règlement sur le brouillage radio électrique publié par Industrie Canada.

EUROPEAN UNION DECLARATION OF CONFORMITY

This equipment complies with the requirements of the European EMC Directive 89/336/EEC.



CAUTION

Circuit devices are sensitive to static electricity, which can damage their delicate electronics. Dry weather conditions or walking across a carpeted floor may cause you to acquire a static electrical charge.

To protect your switch, always:

- **Touch your computer's metal chassis to ground the static electrical charge before you pick up the switch.**
- **Pick up the switch by holding it on the left and right edges only.**

INSTRUCCIONES DE SEGURIDAD (Normas Oficiales Mexicanas Electrical Safety Statement)

1. Todas las instrucciones de seguridad y operación deberán ser leídas antes de que el aparato eléctrico sea operado.
2. Las instrucciones de seguridad y operación deberán ser guardadas para referencia futura.
3. Todas las advertencias en el aparato eléctrico y en sus instrucciones de operación deben ser respetadas.
4. Todas las instrucciones de operación y uso deben ser seguidas.
5. El aparato eléctrico no deberá ser usado cerca del agua—por ejemplo, cerca de la tina de baño, lavabo, sótano mojado o cerca de una alberca, etc..
6. El aparato eléctrico debe ser usado únicamente con carritos o pedestales que sean recomendados por el fabricante.
7. El aparato eléctrico debe ser montado a la pared o al techo sólo como sea recomendado por el fabricante.
8. Servicio—El usuario no debe intentar dar servicio al equipo eléctrico más allá a lo descrito en las instrucciones de operación. Todo otro servicio deberá ser referido a personal de servicio calificado.
9. El aparato eléctrico debe ser situado de tal manera que su posición no interfiera su uso. La colocación del aparato eléctrico sobre una cama, sofá, alfombra o superficie similar puede bloquear la ventilación, no se debe colocar en libreros o gabinetes que impidan el flujo de aire por los orificios de ventilación.
10. El equipo eléctrico debe ser situado fuera del alcance de fuentes de calor como radiadores, registros de calor, estufas u otros aparatos (incluyendo amplificadores) que producen calor.
11. El aparato eléctrico deberá ser conectado a una fuente de poder sólo del tipo descrito en el instructivo de operación, o como se indique en el aparato.
12. Precaución debe ser tomada de tal manera que la tierra física y la polarización del equipo no sea eliminada.
13. Los cables de la fuente de poder deben ser guiados de tal manera que no sean pisados ni pellizcados por objetos colocados sobre o contra ellos, poniendo particular atención a los contactos y receptáculos donde salen del aparato.
14. El equipo eléctrico debe ser limpiado únicamente de acuerdo a las recomendaciones del fabricante.
15. En caso de existir, una antena externa deberá ser localizada lejos de las líneas de energía.
16. El cable de corriente deberá ser desconectado del equipo cuando el equipo no sea usado por un largo periodo de tiempo.
17. Cuidado debe ser tomado de tal manera que objetos líquidos no sean derramados sobre la cubierta u orificios de ventilación.
18. Servicio por personal calificado deberá ser provisto cuando:
 - A: El cable de poder o el contacto ha sido dañado; u
 - B: Objetos han caído o líquido ha sido derramado dentro del aparato; o
 - C: El aparato ha sido expuesto a la lluvia; o
 - D: El aparato parece no operar normalmente o muestra un cambio en su desempeño; o
 - E: El aparato ha sido tirado o su cubierta ha sido dañada.

TRADEMARKS USED IN THIS MANUAL

ST is a registered trademark of AT&T.

BLACK BOX and the Double Diamond logo are registered trademarks of BB Technologies, Inc.

Any other trademarks mentioned in this manual are acknowledged to be the property of the trademark owners.

1. Specifications

Standards: IEEE802.3u 10/100Base-TX, 100Base-FX, IEEE802.3af Power over Ethernet

UTP Cable: Cat. 5 cable or up, up to 100 meter

Fiber Cable: 50/125, 62.5/125 or 100/140 μ m multi-mode
8.3/125, 8.7/125, 9/125 or 10/125 μ m single-mode

PoE Power Reception Supports: **Endpoint:** via TP pin 1, 2, 3, 6

Midspan: via TP pin 4, 5, 7, 8

LED Indicators: POWER, PoE, TP LNK/ACT, 100, FX LNK/ACT, FDX/COL

Data Transfer Rate: 148,800 pps at 100 Mbps; 14,880 pps at 10 Mbps

Flow Control: IEEE802.3x compliant for full duplex; Backpressure flow control for half-duplex

Power Requirement: 60mA@-48VDC from IEEE802.3af PSE or PoE injector

Temperature Tolerance: 32° to 122°F (0° to 50°C)

Relative Humidity: 5% to 90%

Size: 1"H x 2.8"W x 3.7"D (26.2 x 70.3 x 94 mm)

NOTE

For connecting this device to Router, Bridge or Switch, please refer to the corresponding device's Technical Manual.

2. Overview

2.1 Introduction

IEEE 802.3u 100Mbps Fast Ethernet supports two types of media, 10/100Base-TX and 100Base-FX, for network connection. LFP (Link Fault Pass Through) feature enhances the TP-Fiber Link integrity and conformity. Either one of TP or Fiber port is in link-fail state, the LFP converter forces the other port to be at link-disabled state. Comply with IEEE 802.3af, its advanced auto-sensing algorithm enables taking power from IEEE 802.3af Power Source Equipment (PSE) or Power over Ethernet (PoE) injector. It also supports high safety with short circuit protection and power-in auto-detection (power from AC/DC power adapter or PSE device).

2.2 Model Description

Part Number	Single/Multi Mode	Connector Type	Wavelength	Transmission Distance
LPD500A	Multi Mode	SC Type	1310 nm	2 km
LPD501A	Multi Mode	ST Type	1310 nm	2 km
LPD502A	Single Mode	SC Type	1310 nm	20 km
LPD503A	Single Mode	ST Type	1310 nm	20 km
LPD506A	Single Mode	BiDi Type	1310 nm	20 km
LPD507A	Single Mode	BiDi Type	1550 nm	20 km

NOTE

AC-DC +5V Adapter is available upon request.

2.3 What's Included

Your package should contain the following items. If anything is missing or damaged, please contact Black Box at 724-746-5500.

- PD PoE 10/100BASE-TX to 100BASE-FX Media Converter
- CD-ROM containing this user's manual in PDF format

PD PoE 10/100BASE-TX to 100BASE-FX Media Converter

2.4 Hardware Description

Figure 2-1 shows the PD PoE 10/100BASE-TX to 100BASE-FX Media Converter's front panel. The LED indicators in the figure are described in Table 2-1.

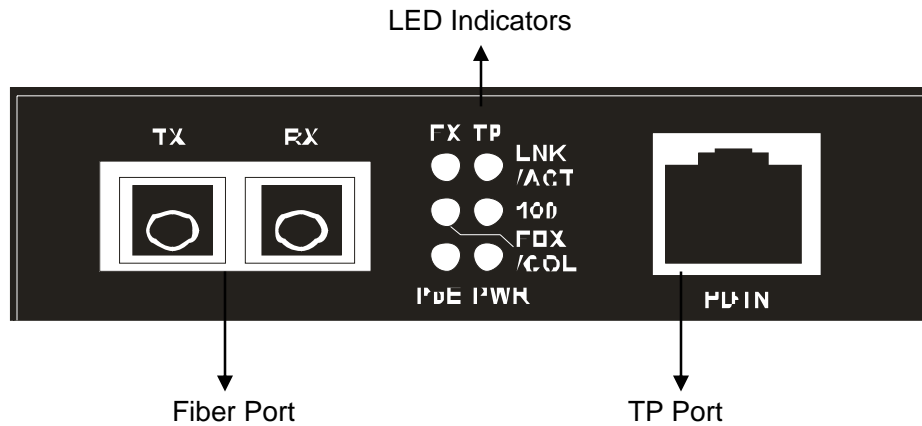
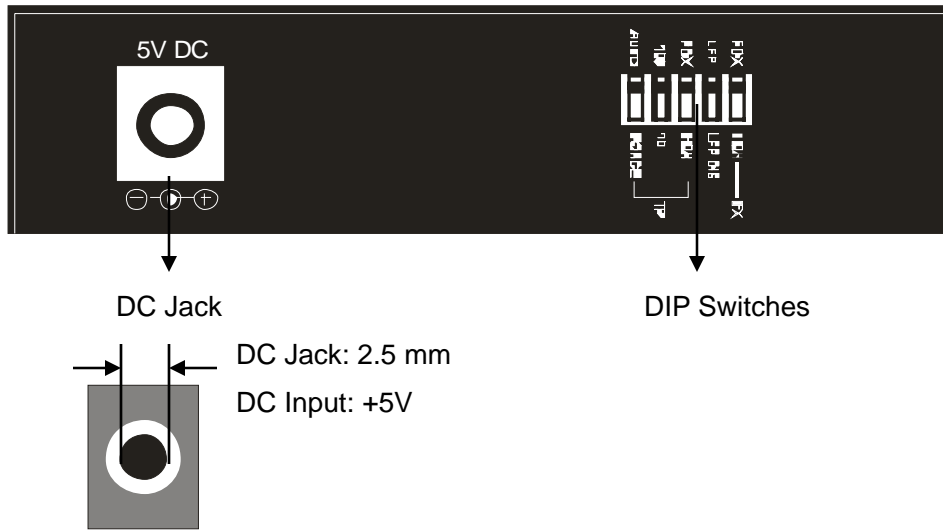

Figure 2-1. Front panel.

Table 2-1. LED indicators.

LED	Color	Function
FX LNK/ACT	Green	Lit when fiber connection is good Blinks when fiber data is present
FX FDX/COL	Amber	Lit when full-duplex mode is active Off when half-duplex is active Blinks when collision is present
TP LNK/ACT	Green	Lit when TP connection is good Blinks when TP data is present
TP 100	Green	Lit when TP speed is 100Mbps Off when TP speed is 10Mbps
PWR	Green	Lit when +5V power is coming up

The media converter's rear panel is shown in Figure 2-2.



DC jack's central post is 2.5 mm wide.

Figure 2-2. Rear panel.

3. Installing the Converter

3.1 Installing Instruction

CAUTION

Wear a grounding device to avoid damage from electrostatic discharge.

Be sure that the power switch is OFF before you connect the power cord to the power source.

1. Install the TP media cable to the IEEE 802.3af PSE device or PoE injector. (See Figure 3-1)
2. Install the media cable for network connection.

NOTE

Please make sure that the power of PSE device is turned on, or else the converter will not work.

3. In case where no 802.3af PSE is available or PSE with PoE power fails, you may install an AC-DC adapter for a backup solution.

CAUTION

Do not connect PSE TP with PoE and the AC-DC adapter at the same time.

Verify that the AC-DC adapter conforms to your country AC power requirement and then insert the power plug.

4. Install the media cable for network connection.

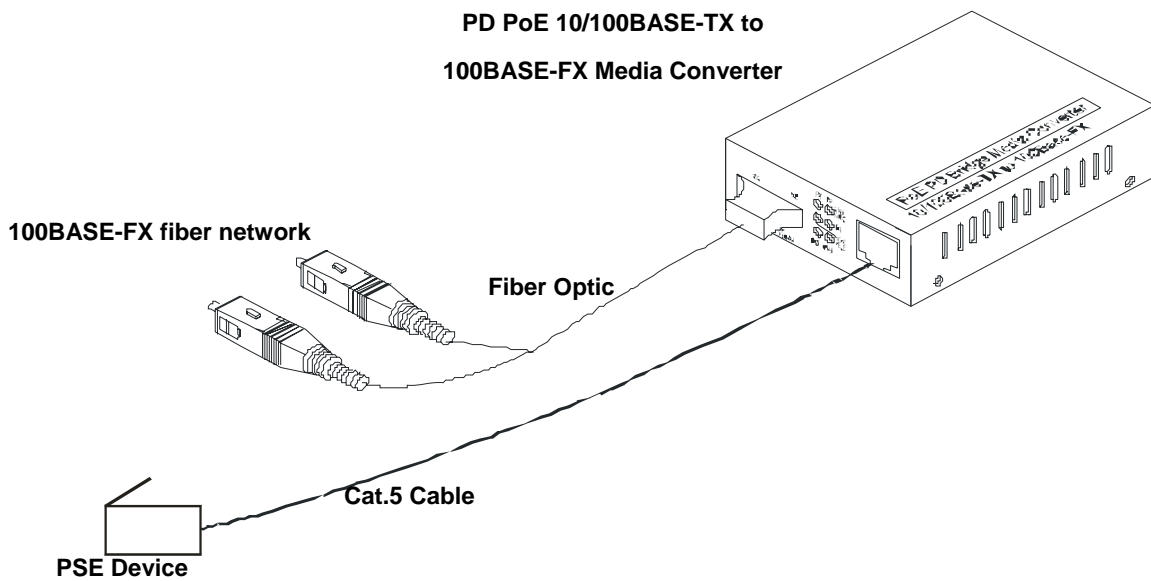

Figure 3-1 Connection among PSE PoE Converter and TP Cables

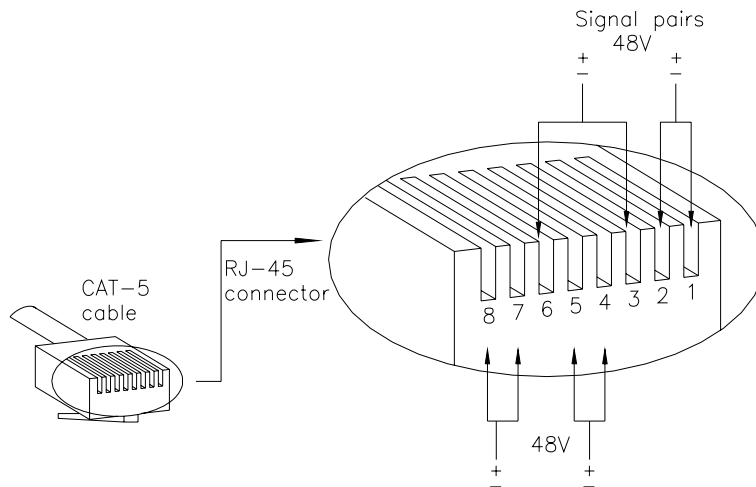

Figure 3-2 Endpoint PSE RJ-45 Male Connector

NOTE

IEEE 802.3af assigns pairs on the RJ-45 connector and Cat.5 cable of Endpoint PSE.

Endpoint: -48V via TP pin 1, 2, 3, 6

Midspan: -48V via TP pin 4, 5, 7, 8

3.2 Connecting to TP, Fiber Device

Converter TP Port 10/100 TP

AUTO, FORCE selectable: Bit 1, 2, 3 of S1

- a. AUTO: 10/100 NWay Auto-negotiation
- b. FORCE: 100 or 10, FDX or HDX

Converter Fiber Port 100FX

100Mbps duplex selectable: Bit 5 of S1

- a. FDX for 100FDX fiber link partner, default
- b. HDX for 100HDX fiber link partner

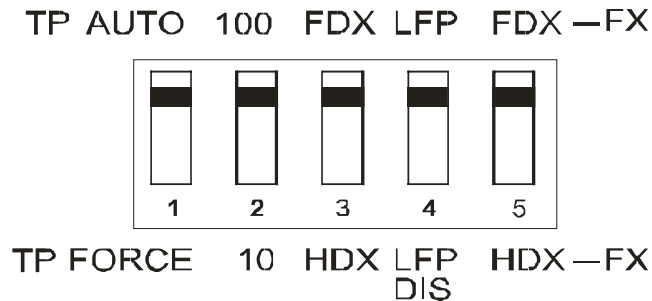

Figure 3-3 S1—Bit 1, 2, 3, 4, 5 configuration and setting

- S1-1 TP port mode : AUTO(default) or FORCE
- S1-2 TP port speed : 100 or 10 when TP at Force
- S1-3 TP port duplex : FDX or HDX when TP at Force
- S1-4 LFP : LFP enabled(default) or disabled
- S1-5 Fiber port duplex : 100FDX(default) or 100HDX

NOTE

1. S1-2 and S1-3 will take effect only when S1-1 is set at TP-FORCE.
2. S1-5 must be set to 100FDX for Single Fiber Model.

Warning

When TP Nway port is connected to TP 100FDX(force mode) instead of Nway partner, it will result in 100HDX mode with invalid collision signal.

Ensure that all network nodes are configured at an identical operation mode. Improper operation and flow control mode between TP and Fiber port connections will render the LAN to work poorly.

3.3 Cable Connection Parameter

100Base-X network allows 512-bit time delay between any two node-stations in a collision domain. Switch-based Media Converter breaks up TP and Fiber segments' collision domain to extend the cabling distance.

TP Cable Limitations: Cat. 5 and up to 100m

Converter Fiber Cable Limitations:

Multi-mode Half-duplex	412 m
Multi-mode Full-duplex	2 km
Single-mode Half-duplex	412 m
Single-mode Full-duplex	20 km

4. Link Fault Pass Through

This media converter supports link fault pass through (LFP) in TX/FX converter application. Link status on one port is propagated to the other port to notice the remote nodes. If TP port is unplugged, this converter stops transmission on fiber port. This causes the remote fiber node link to fail. LED shows the link failure on both TP and fiber ports. If fiber link fails, this converter restarts auto-negotiation on TP port but always stays in the link failure state. This causes the remote TP node link to fail. LED also shows the link failure on both TP and fiber ports. Refer to Figure 4-1 shown below for the normal status when the link succeeds. Also refer to Figure 4-2 and Figure 4-3 for the erroneous status when TP Cable A, Fiber Cable B or Fiber Cable C fails to connect.

NOTE

- indicates LNK/ACT LED Lit
- indicates LNK/ACT LED Off

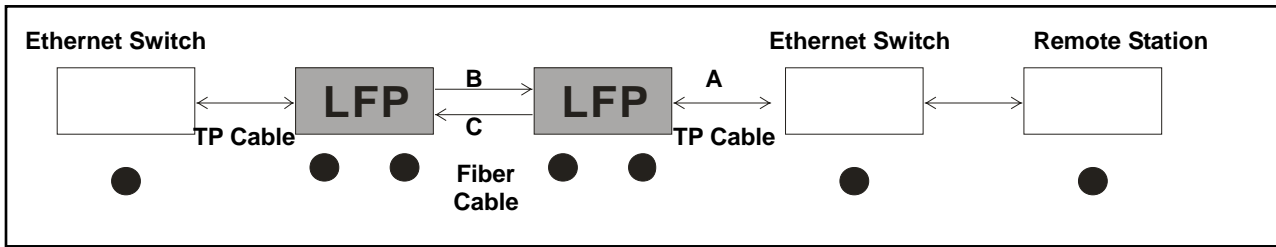

Figure 4-1 Normal status via a pair of LFPs

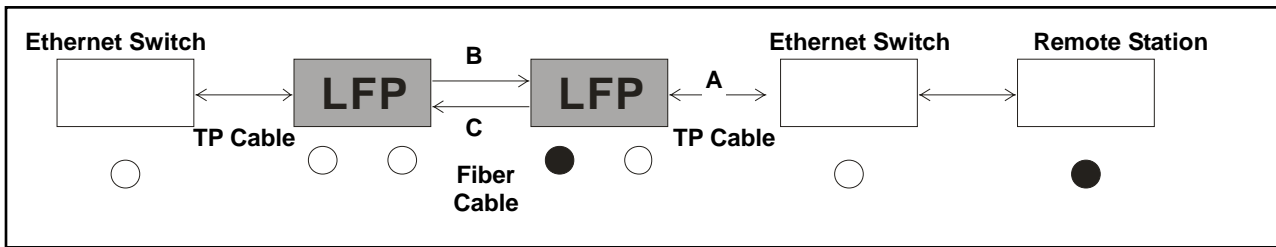

Figure 4-2 The status as TP Cable A is broken

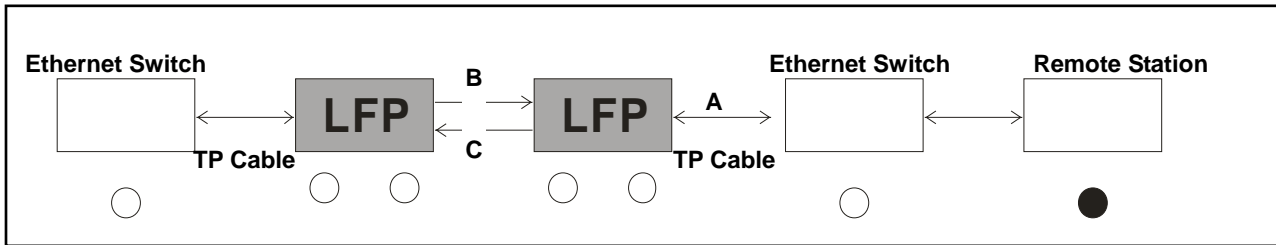

Figure 4-3 The status as Fiber Cable B or C is broken

Warning

The LFP (Link Fault Pass Through) function works only when both two converters own this capability in pairs. Furthermore, both LFP converters should be supplied only by the same manufacturer/vender. The connection coming from LFP converters with odd models or non-LFP converters will cease the LFP function.

5. Troubleshooting

5.1 Calling Black Box

If you determine that your switch is malfunctioning, do not attempt to alter or repair the unit. It contains no user-serviceable parts. Contact Black Box at 724-746-5500.

Before you do, make a record of the history of the problem. We will be able to provide more efficient and accurate assistance if you have a complete description, including:

- the nature and duration of the problem.
- when the problem occurs.
- the components involved in the problem.
- any particular application that, when used, appears to create the problem or make it worse.

5.2 Shipping and Packaging

If you need to transport or ship your PD PoE 10/100BASE-TX to 100BASE-FX Media Converter:

- Package it carefully. We recommend that you use the original container.
- If you are shipping the PD PoE 10/100BASE-TX to 100BASE-FX Media Converter for repair, make sure you include everything that came in the original package. Before you ship, contact Black Box to get a Return Authorization (RA) number.