

Custom Cables and Adapters

When you need it made to order,
count on Black Box.

- Cables, Adapters, Faceplates
- Pinning
- Striping
- Colouring
- Kitting
- Labeling
- Bundling
- Packaging
- Shipping

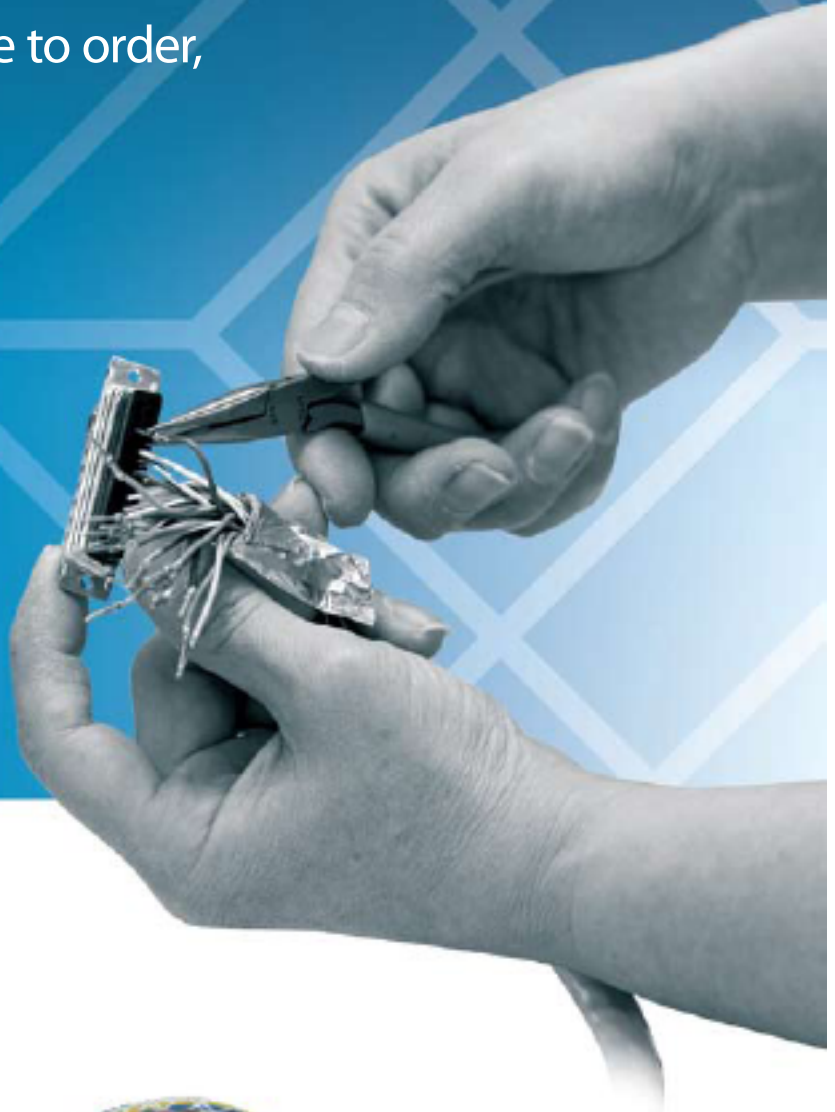

Specialised/custom cable



Custom striping/colours/bundling



Custom wallplates and adapters

When you need the hard-to-find,

Can't find it anywhere? You'll find it at Black Box. If we don't stock it, we'll make it for you.

Sure, we offer more than 12,000 products every day in our catalogues and on our website. But when you're looking for more than an everyday solution, or when "off-the-shelf" just won't do, call Black Box.

For 35 years, Black Box has helped customers solve their unique connectivity problems.



Special requirements are no problem. Every day, experienced technicians in our manufacturing facility in the USA, build custom cable assemblies, wallplates, switches, and more.



Stay organised with custom labels. Let us know what you need, and we'll make them for you.

Not only do we modify existing cables and adapters, we also build them from scratch to your specs! UTP, fibre optic, RS-232, coax, A/V—tell us what you need, and we'll turn your ideas into reality.

- We design and build more than 200,000 custom products each year.
- We produce more than 150,000 custom cables each year.
- We can provide custom pinning, labeling, packaging, kitting, and bar coding and ship your products according to your schedule.
- We can stripe, colour, and bundle to your specs.
- We'll design custom fibre assemblies just for you.



DB15 adapter modified with BNCs.

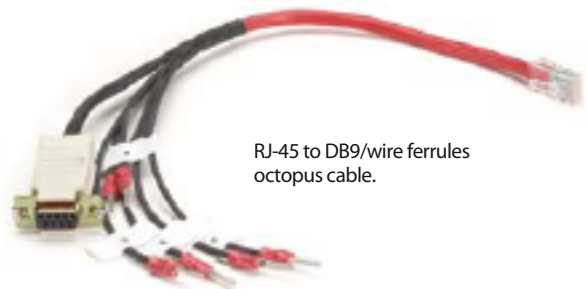

RJ-45 to DB9/wire ferrules octopus cable.



Need single-, dual-, 3-, or 4-gang wallplates? Tell us the connectors and configurations you need and we'll build them for you.

find it at Black Box.



DB25 to BNC octopus cable.

For 35 years, Black Box has helped customers solve their unique connectivity problems.

Some of our custom capabilities

Bundled CAT5e and CAT6 Bulk Cable
Black Box saves you time by delivering bundled cables with the exact number of cables of the type and length you need. You can even specify colour. Pull cable once and you're done. Ask about our bundled fibre cables, too.

Dyed, striped, UV, and more
Camouflage? Company colours? Red, white, and blue? Show your colours with Black Box Custom Cable.

We provide you with just the kind of cable solution you need, whether it's special colours or striping for easy identification, or even cable that can stand up to the sun's UV rays.

Custom cables
We've built custom cables with special snap-on/off connections for security

applications. We can also build custom Y and large octopus cables with extremely unusual connector combinations.

Custom fibre colours
Choose from as many as 12 colours and get the convenience of standard part numbers, too. For details, see page 6.

Adapters
Tell us the specific pairing, jumpers, and drains you need. Not sure? Describe your application, and our Tech Support experts will help you. We even do quick connect/disconnect adapters for industrial applications. Have legacy equipment and can't find adapters? We'll make them for you.

Feed-through faceplates
Need custom faceplates for your conference rooms, classrooms, or digital signage

displays? Black Box can customise feed-through faceplates for your installation with the connectors of your choice: CAT5e, CAT6, fibre optic, VGA, audio, S-Video, and more.

Labeling, kitting, shipping
Let us keep you organised. We'll label and bar code your order and provide exactly the packaging you want. We'll assemble kits of components to your specs, on your schedule.

To get started, just call our FREE Tech Support hotline or see our configurators at www.blackbox.co.uk.

After you submit your request to our engineers for review, a Black Box representative will contact you, typically within 24 hours with a quote.

Connector Guide

D-Style Connectors



Keyboard/Video/Audio

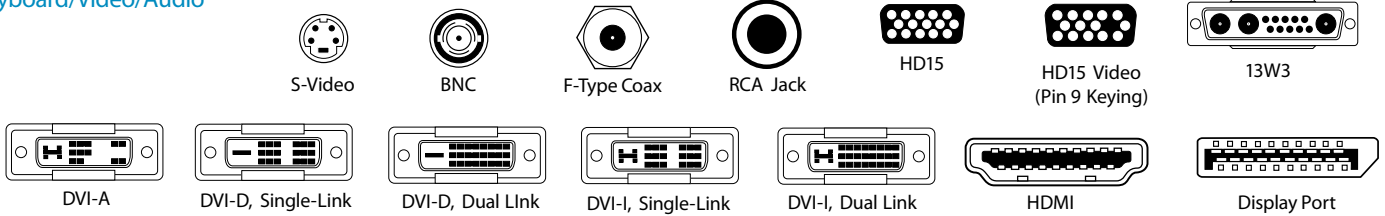

Fibre Connectors

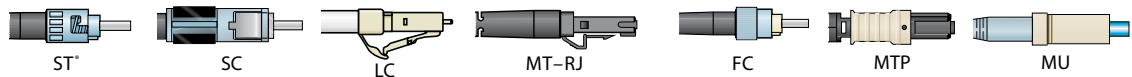

USB & FireWire Connectors

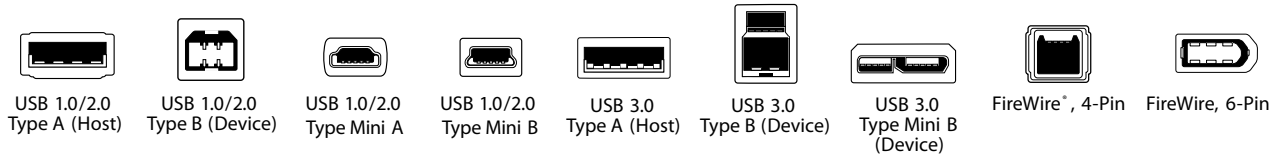

Modular Connectors

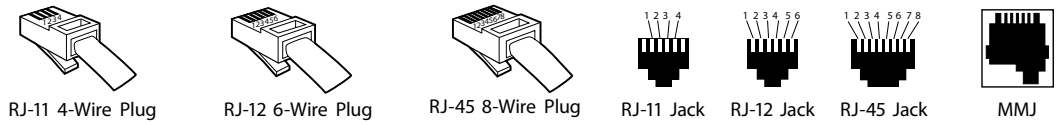

DIN-Type Connectors



Centronics Connectors



SCSI Connectors

Need help identifying a connector? Call Tech Support! 0118 965 6000

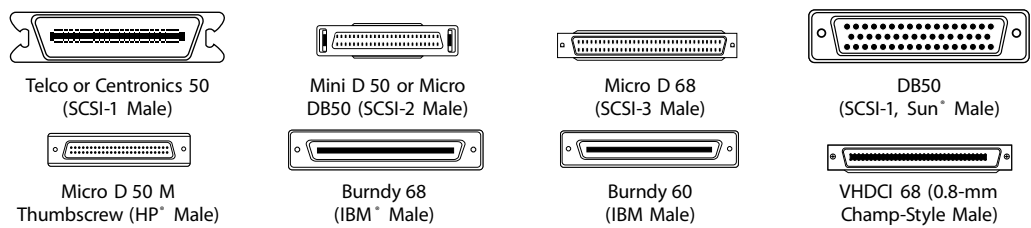

M-Block Connectors



Coax & Twinax Connectors



Miscellaneous Connectors

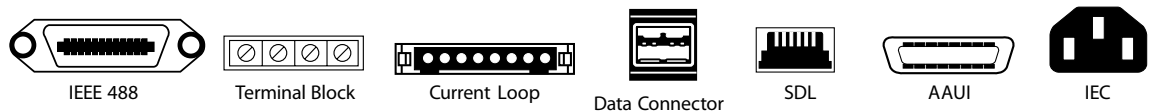

Data Interface Pinning

RS-232 Interface (DB25)

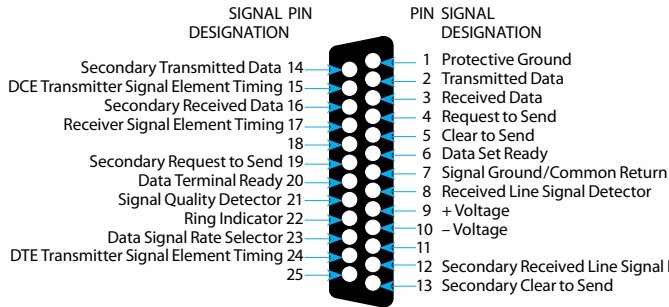

RS-530 Interface (DB25)

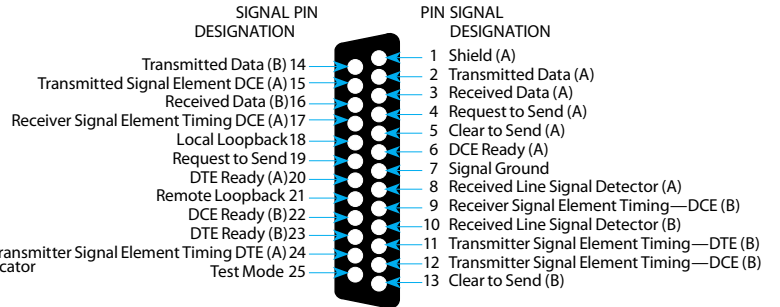

RS-449 Interface (DB37)

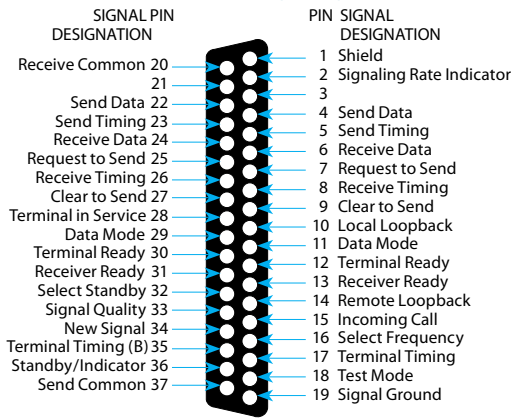

V.35 Interface (M/34)

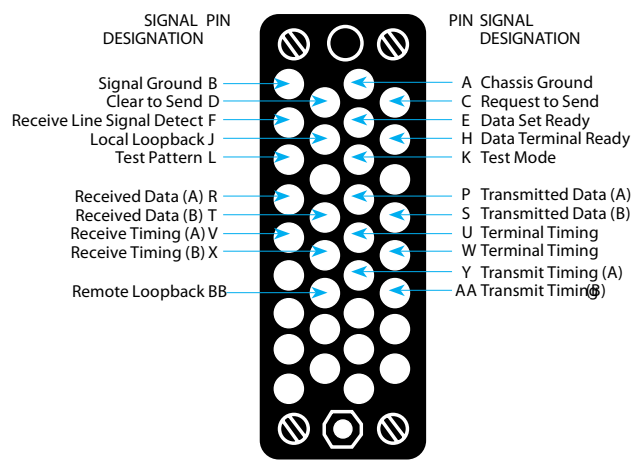

Centronics * Parallel Interface

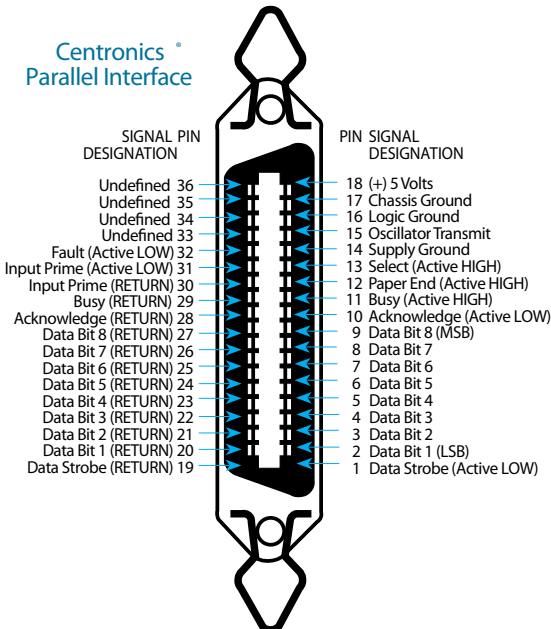

VGA Video Interface (HD15)

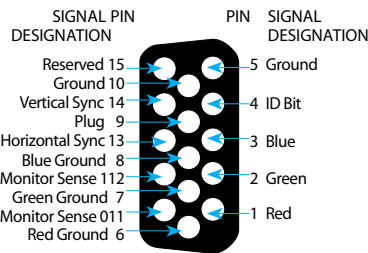

RS-232 Interface (DB9)

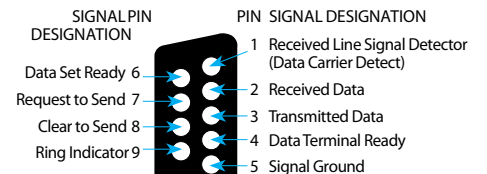

IBM PS/2 Keyboard Interface (6-Pin Mini DIN)

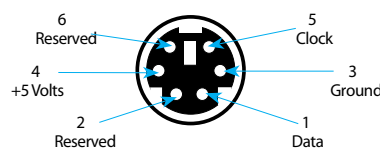

USB Mini Type A

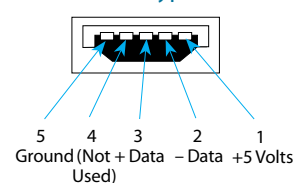

USB Type A

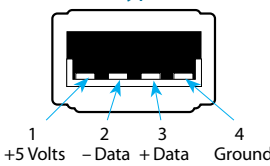

USB Type B

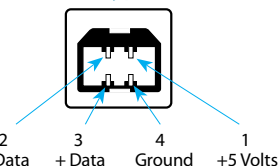

USB Mini Type B

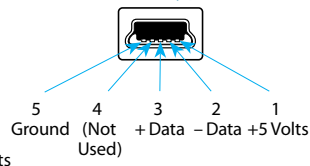

USB Micro Type B

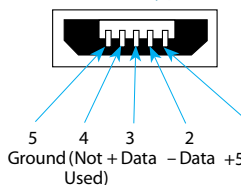

USB Micro Type A/B

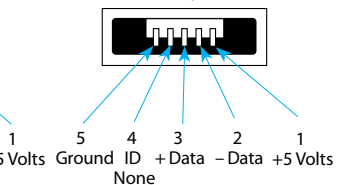

Custom fibre with the convenience of standard part numbers.

Match Black Box fibre cable to your company, team, or school colours for that special networking application in the data centre and the desktop. It's ideal for colour-coded applications, too. Plus, it's guaranteed for life! Use the Buyer's Guide below to build your custom cable.

Choose from as many as 12 colours!

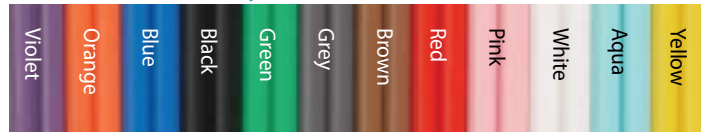

Buyer's Guide | Multicolour Fiber Optic Patch Cables

1 (Constant)	2 Jacket	3 Core Size	4 Length	5 M- (Constant)	6 Connectors	7 Colour
FO	CMR = PVC CMP = Plenum	62 = 62.5 Micron	001 = 1 Metre	M	STST = ST to ST	BL = Blue
		50 = 50 Micron	002 = 2 Metres		SCSC = SC to SC	OR = Orange
	SM = Single-Mode	003 = 3 Metres	LCLC = LC to LC		GN = Green	
	10 = 10 Gig	004 = 4 Metres	MTMT = MT-RJ to MT-RJ		BR = Brown	
		005 = 5 Metres	STSC = ST to SC		GR = Grey	
		006 = 6 Metres	STLC = ST to LC		WH = White	
		007 = 7 Metres	STMT = ST to MT-RJ		RD = Red	
		008 = 8 Metres	SCLC = SC to LC		BK = Black	
		010 = 10 Metres	LCMT = LC to MT-RJ		YL = Yellow	
		015 = 15 Metres	SCMT = SC to MT-RJ		VT = Violet	
	020 = 20 Metres		PK = Pink			
	025 = 25 Metres		AQ = Aqua			
	030 = 30 Metres					

Examples of fibre optic cable codes:
 FOCMR62-001M-STST-BL = Cable with a PVC jacket, 62.5-micron core, 1-metre length, ST-ST connectors in blue.
 FOCMR50-008M-STLC-OR = Cable with a PVC jacket, 50-micron core, 8-metre length, ST-LC connectors in orange.
 FOCMRSM-030M-SCLCYL = Cable with a PVC jacket, 9-micron core, 30-metre length, SC-LC connectors in yellow.

NOTE: These cables are made to order. Orders cannot be cancelled or returned.

Misys Healthcare Systems: Custom Adapters

One of the many services and products Misys Healthcare Systems provides for healthcare organisations is software and instrumentation for medical laboratories.

Misys developed a new system for one of its clients that involved new instrumentation and software at three different sites. For the system to be properly connected, it required adapters with custom pinning. The Misys rep called Black Box and explained what type of adapters were needed. Black Box provided the quote and said the custom adapters would take a week or more.

Unfortunately, critical system testing was about to begin in a few days. When the Black Box rep heard about the tight time frame, she went the extra mile to get the adapters produced and shipped in two days—plenty of time for the system launch.

“The crunch was on when the Black Box rep called back. She worked magic and was able to get the custom adapters out to us in two days—literally! Not only were we ecstatic, but the client was very happy and relieved. Awesome teamwork!”

Jaime Schisel
Instrument Specialist
Misys Healthcare Systems

Custom Cable Request Form

(Page 1 of 2)

Create your own custom cable with this form by indicating cable type, length, and jacket type as well as connector gender, connector type, and special instructions. If you select foil shielded as the cable type, remember to circle your drain-wire option. Lastly, indicate your pinning requirements.

You can also configure Custom Cables with our Cable & Adapter Configurator at www.blackbox.co.uk. After you've submitted the form, you'll receive a confirmation e-mail, and your quote will be completed within 24 hours. Need help? Call our FREE Tech Support at 0118 965 6000.

1 Cable Type: (Check as many as apply)

- | | |
|---|--|
| <input type="checkbox"/> CAT5e | <input type="checkbox"/> 62.5/125-µm Multimode Fibre |
| <input type="checkbox"/> CAT6 | <input type="checkbox"/> 50/125-µm Multimode Fibre |
| <input type="checkbox"/> CAT6a | <input type="checkbox"/> 50/125-µm (OM3) Multimode Fibre |
| <input type="checkbox"/> Unshielded | <input type="checkbox"/> 8.5/125-µm Single-Mode Fibre |
| <input type="checkbox"/> Foil Shielded | <input type="checkbox"/> Simplex Fibre |
| <input type="checkbox"/> Foil and Copper-Braid Shielded | <input type="checkbox"/> Duplex Fibre |
| <input type="checkbox"/> Solid | <input type="checkbox"/> Other: _____ |
| <input type="checkbox"/> Stranded | |

- Jacket Type:**
 PVC LSZH

Standard Cable-Length Tolerances	
0–9.9 ft.	+3"/-0"
10–99.9 ft.	+6"/-0"
100 ft.+	+1 ft./-0"

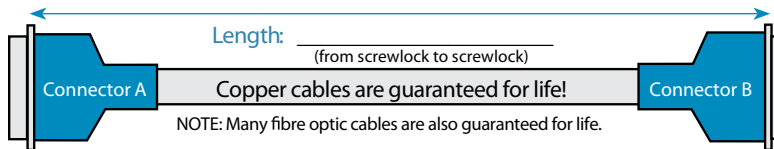

2 Connectors:

Gender: M F

Connector Type: (Circle one)

- | | | |
|------------------------|----------------------------|--------------------|
| 1. DB9 | 12. RJ-45 8-wire | 22. Fibre FDDI |
| 2. DB15 | 13. DEC™ MMJ | 23. M/34 (V.35) |
| 3. DB25 | 14. RJ-45 10-wire | 24. 50-pin Berg: |
| 4. DB37 | 15. RJ-45 8-wire, shielded | RS-232 or SCSI |
| 5. DB50 | 16. M/50 | 25. 4-pin mini DIN |
| 6. 15-pin high-density | 17. Fibre ST * | 26. 5-pin DIN |
| 7. 36-pin Centronics * | 18. Fibre SC | 27. 6-pin mini DIN |
| 8. 50-pin telco | 19. Fibre LC | 28. 8-pin mini DIN |
| 9. RJ-11 4-wire | 20. Fibre MT-RJ | 29. Spade lugs |
| 10. RJ-11 6-wire | 21. Fibre MU | length: _____ |
| 11. RJ-22 4-wire | | 30. Other _____ |

Special Instructions: (Circle options)

- One end cut
- Pins only
- Hood type (Plastic if not specified):
 Metal hood • 45° hood • Removable hood
 Plastic hood • Molded hood
- Thumbscrews
- Screw locks: M or F (Male if not specified) metric/English
- 90° hood—specify cable exit, Pin # _____
NOTE: Default is Male=Pin 1, Female=Opposite
- Pairing
- Flying leads, length: _____
- Label: _____
- 50-pin telco: ears or bail latches
- 36-pin Centronics: ears or bail latches
- Packaging—please attach specs
- Other—please attach specs

Drain Wire: (Circle one)

(Applies only to foil-shielded cables)

- Cut drain wire
 - Pin drain by itself Pin # _____
 - Wrap drain with conductor Pin # _____
- If 1–3 are not chosen,
 4. Attach drain to shell

Gender: M F

Connector Type: (Circle one)

- | | | |
|------------------------|----------------------------|--------------------|
| 1. DB9 | 13. DEC MMJ | 24. 50-pin Berg: |
| 2. DB15 | 14. RJ-45 10-wire | RS-232 or SCSI |
| 3. DB25 | 15. RJ-45 8-wire, shielded | 25. 4-pin mini DIN |
| 4. DB37 | 16. M/50 | 26. 5-pin DIN |
| 5. DB50 | 17. Fibre ST | 27. 6-pin mini DIN |
| 6. 15-pin high-density | 18. Fibre SC | 28. 8-pin mini DIN |
| 7. 36-pin Centronics | 19. Fibre LC | 29. Spade lugs, |
| 8. 50-pin telco | 20. Fibre MT-RJ | length: _____ |
| 9. RJ-11 4-wire | 21. Fibre MU | 30. Other: _____ |
| 10. RJ-11 6-wire | 22. Fibre FDDI | |
| 11. RJ-22 4-wire | 23. M/34 (V.35) | |
| 12. RJ-45 8-wire | | |

Special Instructions: (Circle options)

- One end cut
- Pins only
- Hood type (Plastic if not specified):
 Metal hood • 45° hood • Removable hood
 Plastic hood • Molded hood
- Thumbscrews
- Screw locks: M or F (Male if not specified) metric/English
- 90° hood—specify cable exit, Pin # _____
NOTE: Default is Male=Pin 1, Female=Opposite
- Pairing
- Flying leads, length: _____
- Label: _____
- 50-pin telco: ears or bail latches
- 36-pin Centronics: ears or bail latches
- Packaging—please attach specs
- Other—please attach specs

Drain Wire: (Circle one)

(Applies only to foil-shielded cables)

- Cut drain wire
 - Pin drain by itself Pin # _____
 - Wrap drain with conductor Pin # _____
- If 1–3 are not chosen,
 4. Attach drain to shell

COPY AND FAX THIS FORM TO 0118 965 5001

Custom Wallplate Request Form

Custom Wallplate Request Form

Create your own custom multimedia stainless steel wallplate for RJ-11, RJ-45, D-Sub, coax, audio, and video connections.

1 Select a wallplate (one wallplate layout per form):



Single-Gang



Dual-gang

2 Select the connector types (write in quantity):

NOTE: The type and the number of connectors you choose may not all fit onto the selected wallplate. If you have any questions, contact Tech Support at 0118 965 6000.

NOTE: The first gender indicates the wallplate's face gender.

D-Style Feed-Through

	DB9	DB15	DB25	HD15
Male/Female				
Female/Male				
Male/Male				
Female/Female				

D-Style Solder Type

	DB9	DB15	DB25	HD15
Male				
Female				

DVI Adapters

DVI-I/D/A Female/Female Qty: _____

Coax Connectors (Female Only)

	BNC	F-Type
Feed-Through		
Solder		

Audio & Video (Female Only)

RCA Quantity for each color(s):

Red White _____
Yellow Blue _____
Green Black _____

	3.5 mm	1/4"
Feed-Through, Mono		
Feed-Through, Stereo		
Solder-Type, Mono		
Solder-Type, Stereo		

HDMI (Feed-through) _____ S-Video (feed-through) _____

RJ-45 or RJ-11 (110 Punchdown)

CAT6 Quantity for each color(s):

Blue Black _____ Ivory _____
Gray Green _____ Office White _____
Orange Red _____ Telco Ivory _____
White Yellow _____

CAT5e Quantity for each color(s):

Blue Black _____ Ivory _____
Gray Green _____ Office White _____
Orange Red _____ Telco Ivory _____
White Yellow _____

CAT3 Quantity for each color(s):

Blue Black _____ Ivory _____
Gray Green _____ Office White _____
Orange Red _____ Telco Ivory _____
White Yellow _____

RJ-11 Quantity for each color(s):

Blue Black _____ Ivory _____
Gray Green _____ Office White _____
Orange Red _____ White _____
Yellow _____

RJ-45 or RJ-11, Feed-through (Qty):

CAT5e CAT6 _____ RJ-45 _____ RJ-11 _____

3 Write the connector name where it should be positioned on the wallplate.

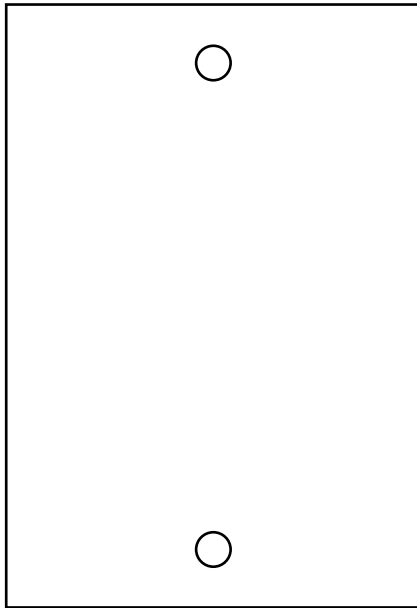

Single-gang

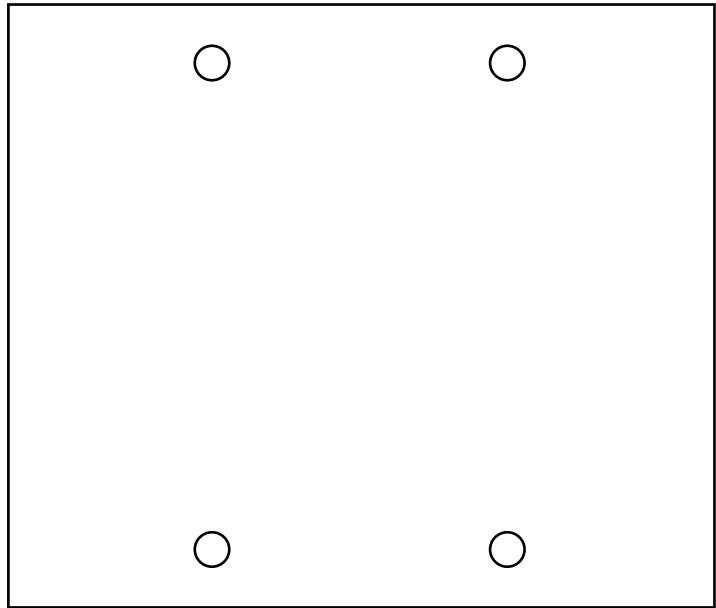

Dual-gang

Examples:

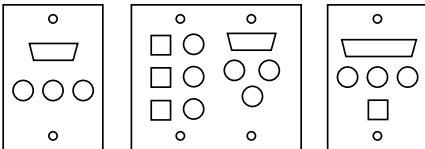

4 Enter customer information and quantities.

Part number: _____	Name : _____
Contact number: _____	Title : _____
Quote number: _____	Company: _____
Order number: _____	Address _____
Comments: _____	or P.O. B ox: _____
	Mail Stop / _____
_____	Suite /Building : _____
_____	City: _____
_____	County: _____ Postcode: _____
_____	Telephone :() _____
_____	Fax:() _____
_____	E-mail: _____

5 easy ways to order!

1. Phone: 0118 965 6000 —
24 hours a day, 7 days a week
2. On-line: www.blackbox.co.uk
3. E-mail: orders@blackbox.co.uk
4. Fax: 0118 965 5001
5. Mail: 464 Basingstoke Road
Reading, Berkshire
RG2 0BG

24-Hour Response!

Quantity : _____

Thank you!

Have a question?
Need technical help?.

Call our FREE Tech Support hotline
on 0118 965 6000. You'll be live with
a technical expert in 20 seconds or less .



Call us on 0118 965 6000 to learn more.